



# SHEET PLATE FILM EQUIPMENT



Sheet  
Extrusion Line



Plate&Film  
Extrusion Line

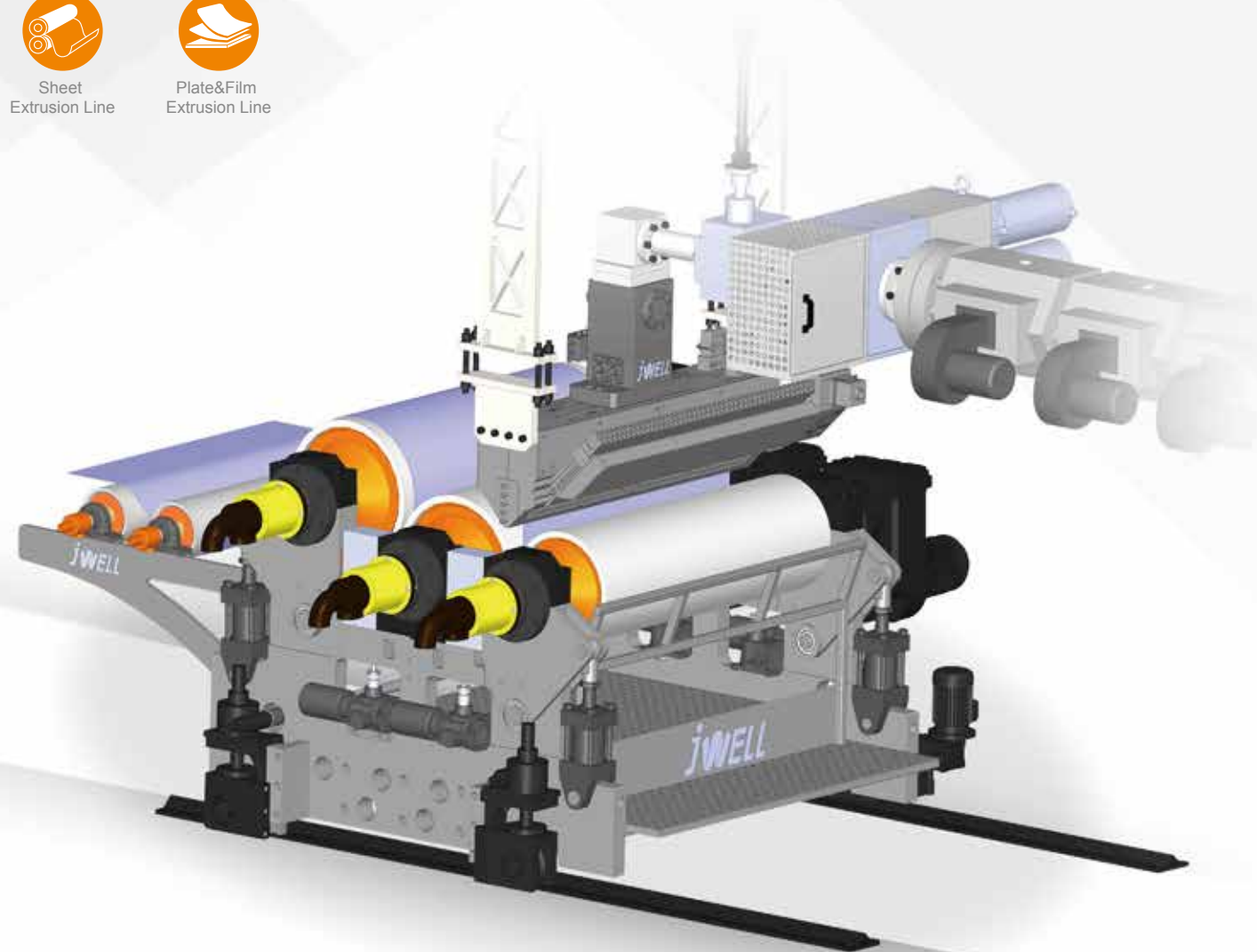

**常州金纬片板设备  
制造有限公司**

江苏省常州市溧阳中关村开发区  
上上路118号 邮编: 213300

电话: 0519-87878918  
13916825715  
传真: +86-519-87878958

**CHANGZHOU JWELL  
PLATE&SHEET EQUIPMENT**

No.118,shangshang Road,Licheng Town,Liyang,  
Changzhou city,China. 213300

Tel: +86-519-87878918  
+86-13916825715  
Fax: +86-519-87878958

E-mail: sales@jwell.cn  
Complaint E-mail: info@jwell.cn

©常州金纬片板保留所有权和解释权。若有修改恕不另行通知。 Http://www.jwell-sheet.com  
版本号Edition No.2022.03 Http://www.jwell-sheet.cn



扫一扫  
关注常州金纬片板微信



**常州金纬片板设备制造有限公司**

CHANGZHOU JWELL PLATE&SHEET EQUIPMENT CO., LTD.



**常州金纬片板设备制造有限公司简介:**

常州金纬片板设备制造有限公司是上海金纬公司的又一重要发展战略中心,其坐落于江苏省溧阳市江苏中关村科技产业园内,是一家致力于塑料挤出成型设备的研发、制造的高科技厂家。厂区占地面积 300 余亩,公司拥有一支高素质的研发队伍和经验丰富的机械、电气调试工程师团队,以及先进的机械加工基地和规范的装配车间。公司本着“用心持久、拼搏创新”的企业精神,不断探求挤出新领域的开拓。热烈欢迎国内外新老客户莅临我司参观、指导、合作、我们愿为您提供强有力的支持。



公司产品已遍布全国各地,并出口到俄罗斯、印度、韩国、印尼、中东、非洲和南美洲、西班牙、意大利等100多个国家和地区,深受客户好评。

**“品质卓越 完美如一”**

是金纬公司的质量方针,是全体员工努力的方向。

**“诚实待人”**

是我们铸就“百年金纬”的核心理念。

董事长:何海潮 E-mail: he@jwell.cn

CHANGZHOU JWELL PLATE&SHEET EQUIPMENT CO., LTD.is another developmentstrategy center of Shanghai JWELL Machinery Co.,ltd, locating at Jiangsu zhongguancun technology industrial park, Liyang city, Jiangsu province, a high-tech manufacturer specializing in research and development of plastic extrusion equipment. The factory area is of 300 acres;We have a high qualified R&D and experienced mechanical and electrical engineer team as well as advanced processing foundation and normative assembly shop.Our enterprise spirit is "Attentive, Enduring, Quick and Orderly" ,keeping on exploring of new extrusion field. Mostly welcome to new and old customers to visit us for investigation, guidance and cooperation. We are happy to offer powerful support!



Our customers are all over China, and we have customers in Russia, India, Korea, Indonesia, Middle East, South America, Spain, Italy and other countries. Our machines are well accepted by our customers.

President:He Haichao Mobile /WhatsApp +86 13601628188





## PLA (聚乳酸)/PET单螺杆片材生产线 PLA (Polylactic Acid), PET Single Screw Sheet Extrusion Line



PLA(聚乳酸)是一种新型的生物基及可再生生物降解材料，使用可再生的植物资源(如玉米、木薯等)所提出的淀粉原料制成。聚乳酸的生产过程无污染，而且产品可以生物降解，实现在自然界中的循环，因此是理想的绿色高分子材料。聚乳酸的热稳定性好，加工温度170~230℃，有好的抗溶剂性，由聚乳酸制成的产品除能生物降解外，生物相容性、光泽度、透明性、手感和耐热性好，还具有一定的抗菌性、阻燃性和抗紫外性，因此用途十分广泛，可用于水果，蔬菜，鸡蛋，熟食和烘烤食品的硬包装，也可用于三明治，饼干和鲜花等商品的包装。

PLA (Polylactic Acid) is a novel biobased and renewable biodegradable material made from starch raw materials proposed by renewable plant resources such as corn and cassava. The production process of PLA is non-polluting, and the product can be biodegraded to achieve circulation in nature, so it is an ideal green polymer material. PLA has good thermal stability, processing temperature of 170-230°C, with good solvent resistance. Products made of PLA have the advantage of biodegradability, gloss, transparency, good feel and heat resistance. It also has good antibacterial, flame retardant and UV resistance, so it can be used in rigid packaging of fruits, vegetables, eggs, cooked foods and baked goods. It can also be used for the packaging of sandwiches, biscuits and flowers, etc.



### 主要技术参数 Main Technical Parameters

种类 Species	单层线 Multi layer	单层线 Multi layer	单层线 Multi layer	单层线 Multi layer	单层线 Multi layer
挤出机规格 Extruder specification	CJWH75/40-1000	CJWH85/40-1000	JWS120-1000	JWS130-1000	JWS150-1200
制品厚度 Product thickness (mm)	0.2-1.5	0.2-1.5	0.2-1.5	0.2-1.5	0.2-1.5
主电机功率 Main motor power	132	160	132	160	220
最大挤出产量 Max capacity (kg/h)	450	550	500	600	800

备注：以上规格参数如有变更，恕不另行通知。Note: The specifications are subject to change without prior notice.

## 双螺杆免干燥排气型PET片材生产线/PETG装饰膜生产线 Twin Screw Dyer-free Vented PET Sheet Extrusion Line/PETG Decorative Film Extrusion Line



常州金纬推出的双螺杆免干燥排气型PET片材生产线具有低能耗、工艺简单，设备使用维护方便的特点。其特有的螺杆组合结构有效的减少了PET树脂的粘度降，对称式薄壁型辊筒提高了冷却效率同时提升了产能和片材品质，多组分喂料装置可合理的控制新料、回料、色母等的比例，所生产的片材可用于吸塑印刷包装等领域。

Changzhou jwell develops the parallel twin screw extrusion line for PET sheet, this line equipped with degassing system, and no need drying and crystallizing unit. The extrusion line has the properties of low energy consumption, simple production process and easy maintenance. The segmented screw structure can reduce the viscosity loss of PET resin, the symmetrical and thin-wall calender roller heighten the cooling effect and improve the capacity and sheet quality. Multi components dosing feeder can control the percentage of virgin material, recycling material and master batch precisely, the sheet is widely used for thermoforming packaging industry.

PETG膜拥有高光泽，高透明，耐冲击，耐摩擦，耐划性和耐寒性等特性，常用于装饰方面和包装方面，例如家具板，门板，化妆品包装，高周波加工等。

PETG film has the characteristics of high gloss, high transparency, impact resistance, friction resistance, scratch resistance and cold resistance. It is commonly used in decoration and packaging, such as furniture board, door board, cosmetics packaging, high cycle processing, etc.



### 主要技术参数 Main Technical Parameters

机型 Model	共挤线 Multi layer	单层线 Single layer	高效 Highly-efficient
挤出机规格 Extruder specification	JW75&36/40-1000	JW75/40-1000	JW95&52/44-1500
制品厚度 Thickness of the product	0.15-1.5mm	0.15-1.5mm	0.15-1.5mm
主电机功率 Main motor power	110kw/45kw	110kw	250kw/55kw
最大挤出产量 Max extrusion capacity	500kg/h	450kg/h	800-1000kg/h

备注：以上规格参数如有变更，恕不另行通知。Note: The specifications are subject to change without prior notice.



## PP/PS环保片材生产线 PP, PS Environmental Sheet Extrusion Line



研制开发的PP/PS片材生产线，用于生产多层复合环保片材，该片材主要用于吸塑成型各类食品容器和包装，如：托盘、面碗、饭盒、糕盒、水果盘等。该设备可有效的利用石粉比例，既降低片材原料成本，又提高片材的可降解性并保证片材的综合物理性能和后续可加工性能。

Developed by Jwell company, this line is for producing multi-layer environmental-friendly sheet, which is widely used for vacuum forming, green food container and package, different kinds of food packaging container, such as: salver, bowl, canteen, fruit dish, etc. Adopting maxim talc percentage in the sheet production, either customer will be able to reduce the cost of the sheet or increase the sheet degraation character as well as gaining good physical properties and further processing abilities.



### 主要技术参数 Main Technical Parameters

机型 Model	JWS150/120/90-1800	JWS150/60-1200	JWS130/60-1000	JWS120-1000	JWS100-800
片材宽度 Width	1500mm	1000mm	900mm	800mm	600mm
片材厚度 Thickness	0.3-2mm	0.3-2mm	0.3-2mm	0.2-2mm	0.1-0.8mm
生产能力 Capacity	1000-1200kg/h	700-800kg/h	550-600kg/h	400-500kg/h	300-350kg/h

备注：以上规格参数如有变更，恕不另行通知。Note:The specifications are subject to change without prior notice.

## PP/EVA/EVOH/PS/PE多层共挤阻隔片材生产线 PP, EVA, EVOH, PS and PE Multi-Layer Sheet Co-Extrusion Line

### PP、EVA、EVOH、PS、PE多层共挤阻隔片材生产线

由于市场对产品越来越苛刻的要求，金纬开发了先进的五层对称和七层非对称分配技术，使该设备生产出的产品获得了更优异的阻隔性能。

### PP, EVA, EVOH, PS and PE multi-layer sheet co-extrusion line

To meet market's high request on products, JWELL develops advanced technology of five layer symmetrical distribution and seven layer asymmetrical distribution, which makes the sheets having better barrier performance.

### PP/EVA/EVOH/EVA/PP五层或七层共挤复合高阻隔保鲜包装片材

是具有良好的阻气性、阻湿性，是气体阻隔性能良好的一种塑料包装材料。主要应用于果冻包装，高档肉食品、快餐米饭等食品包装，药品、化妆品等包装。

### PP/EVA/EVOH/EVA/PP five or seven multi-layer co-extrusion high barrier fresh keeping sheet

has the excellent anti-oxygen and anti-humidity features. It is one of the best barrier packing materials. Mainly used for Jelly packing, meat packing, snack food packing, medicine and cosmetic packing and so on.

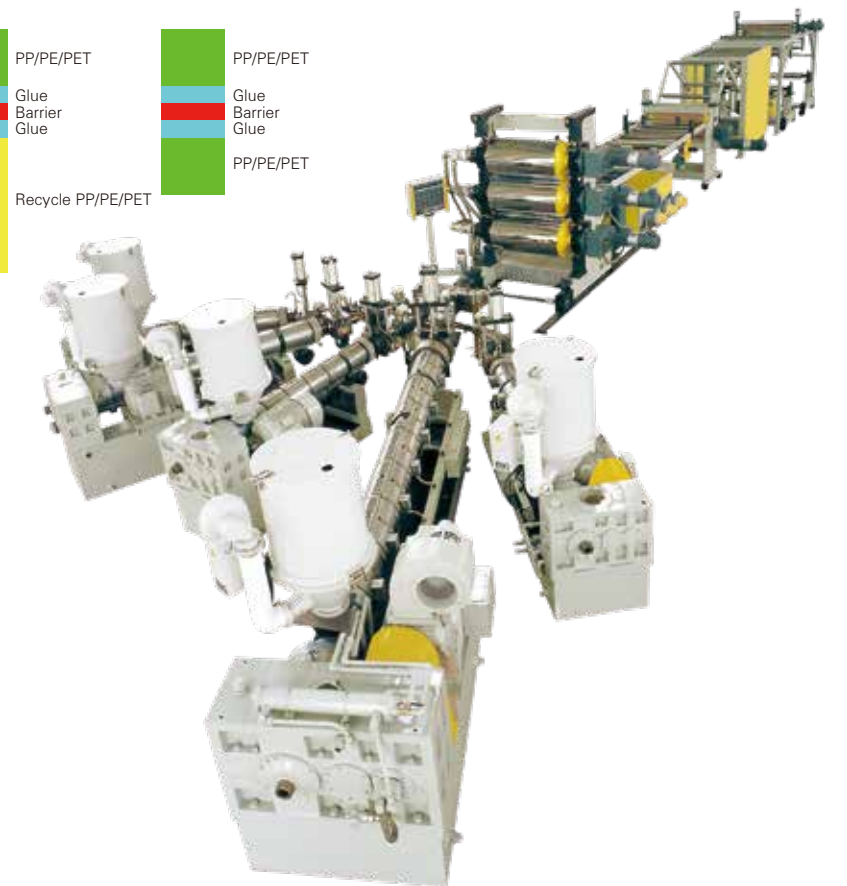
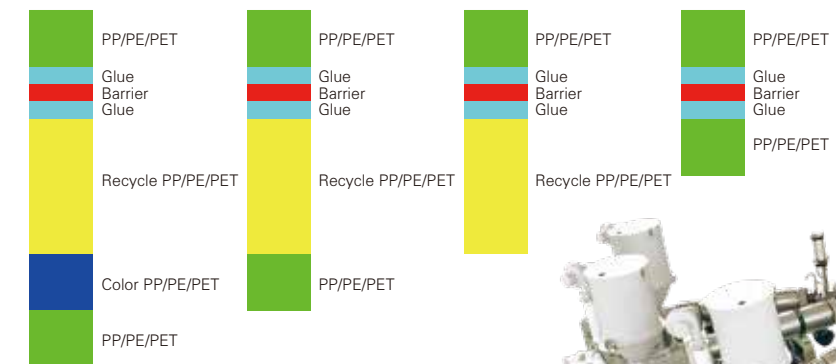

### 主要技术参数 Main Technical Parameters

机型 Model	JW100/45/45-1000	JW120/45/30/65-1200	JW150/45/45-1500
适用原料 Suitable material	PP、PE、PET、PS		
片材宽度 Width	800mm	1000mm	1200mm
片材厚度 Thickness	0.5-2mm	0.5-2mm	0.5-2mm
生产能力 Capacity	300kg/h	400kg/h	650kg/h
设计线速度 Designed line speed	15m/min	20m/min	30m/min
辊筒直径 Calendar diameter	Ø400mm	Ø500mm	Ø600mm

备注：以上规格参数如有变更，恕不另行通知。Note:The specifications are subject to change without prior notice.



## EVA/POE/PVB/SGP胶膜生产线 EVA, POE, PVB, SGP Film Extrusion Line



**EVA/POE 胶膜:** 用于太阳能光伏电站、建筑物玻璃幕墙、汽车玻璃、功能性棚膜、包装膜、热熔胶等各种行业。

**EVA/POE film** is used in solar photovoltaic power station, building glass curtain wall, automobile glass, functional shed film, packaging film, hot melt adhesive and other industries.

**PVB/SGP胶膜:** 广泛应用于建筑夹层玻璃, 汽车夹层玻璃, 防弹玻璃, 隔音玻璃等。具有很好的安全性, 防止玻璃由于外力作用下破碎而碎片溅起伤人; 具有隔音性, 防紫外线, 可以做成彩色或高透明的薄膜。

**PVB/SGP film** is widely used in building sandwich glass, car sandwich glass, bulletproof glass, soundproof glass etc. With good safety function and prevent glass from breaking due to the effect of external force and shards spatter injury; With sound insulation, anti - ultraviolet function, can be made of color or high transparent film.



### 主要技术参数 Main Technical Parameters

机型 Model	适用原料 Suitable material	制品宽度 Products width(mm)	制品厚度 Products thickness(mm)	设计线速度 Designed line speed(m/min)	设计挤出产量 Capacity(kg/h)
JWS120/150/120-2400	EVA/POE	2000-2400	0.38-1.0	15	700-750
JWS180-2400	EVA/POE	2000-2400	0.38-1.0	12	600-700
JWS150	PVB/SGP	2000-2600	0.38-1.52	10	400-500
JWE95-JWE65	PVB/SGP	2400-3000	0.38-1.52	10	600-700
JWE135-JWE95	PVB/SGP	3000-3600	0.38-1.52	20	1000-1200

备注: 以上规格参数如有变更, 恕不另行通知。Note: The specifications are subject to change without prior notice.

## EVA/PVC医用薄膜生产线 EVA, PVC Medical Film

**PVC医用膜广泛应用于:** 医用PVC材料是一种血液相容性的高分子, 在医学用途的高分子PVC材料的实际应用方面, 有非常多的器件必须要与血液相接触, 比如: 各种类型的体外循环系统、介入治疗系统等。应用的产品有: 医用输液袋, 废液袋, 血液透析(视窗)袋、呼吸面罩等。

**PVC medical film** is widely used: medical PVC material is a blood-compatible polymer. In the practical application of polymer PVC material for medical purposes, many devices must be in contact with blood, such as: various Type of extra-corporeal circulation system, interventional treatment system, etc. The products used are: medical infusion bags, waste liquid bags, hemodialysis (window) bags, breathing masks, etc.

**EVA医用膜广泛应用于:** EVA是一种新型的高分子材料, 因其物理化学性能稳定, 弹性好韧性高, 易于加工, 透光度高, 耐腐蚀, 无毒, 无味, 无污染等特点, 目前已广泛应用于食品及医疗耗材领域(如营养液袋, 输血袋等), 已成为国际上普遍信赖和推崇的新一代医疗和食品包装材料。EVA材料制成的袋体透明, 刻度清晰, 方便观察液面位置。

**EVA medical film is widely used:** EVA is a new type of polymer material, because of its stable physical and chemical properties, good elasticity and toughness, easy processing, high light transmission, corrosion resistance, non-toxic, odorless, pollution-free, etc. At present, it has been widely used in the field of food and medical consumables (such as nutrient solution bags, blood transfusion bags, etc.), and has become a new generation of medical and food packaging materials that are generally trusted and respected internationally. The bag body made of EVA material is transparent, and the scale is clear, which is convenient for observing the position of the liquid surface.



### 主要技术参数 Main Technical Parameters

机型 Model	适用原料 Material	螺杆直径 Screw Diameter	制品宽度 Products width	制品厚度 Products thickness	最大挤出量 Capacity (Max.)	主电机功率 Main motor power
SJW120/33-900	PVC/EVA	120mm	900mm	0.15-0.6mm	250KG/H	110KW

备注: 以上规格参数如有变更, 恕不另行通知。Note: The specifications are subject to change without prior notice.



## PC/PMMA/GPPS/ABS塑料片板材生产线 PC, PMMA, GPPS, ABS Plastic Sheet & Plate Extrusion Line



**PC耐力板、波浪板:** 适用范围: 园林、游艺场所奇异装饰及休息场所的廊亭; 商业建筑的内外装饰品, 现代城市楼房的幕墙; 航空透明集装箱、摩托车前风挡、飞机、火车、轮船、汽车、汽船、潜艇及玻璃军警盾牌; 电话亭、广告路牌、灯箱广告展示展览的布置; 高速公路及城市高架路隔音屏障。

**Applicable scope of PC endurance board, PC corrugated sheet:** Garden, recreation place, decoration and the corridor pavilion; Internal and external ornaments in the commercial building, curtain wall of the modern urban building; transparent container of aviation, the windscreen before the motorcycle, the plane, the train, the steamer, the submarine, army and police's shield, the telephone booth, advertising signpost, the advertisement of the lamp houses, the expressway and overhead way of the city partition protective screen.

**ABS、HIPS/GPPS冰箱板 Refrigerator board:**主要用于冰箱冰柜门胆、内胆、抽屉、接水盘、饮水机等。

It has wide application in production of refrigerator door and inner gallbladder, drawers, water dispensers, etc.

**ABS/PMMA复合洁具板 Sanitaryware plate:**用于卫浴产品如: 浴缸、淋浴房、蒸汽房、洗脸槽。

It is widely applied in the field of bath products, such as the bathtub, the shower cabinet, the vapor room, washing bowl, etc.

**ABS/PC复合箱包板 Baggage plate:**主要用于各种拉杆箱、行李箱、休闲包等箱包。

It is mainly applied in field of draw-bar boxes, luggage cases, recreation bags, etc.

**ABS、ABS + PC合金料汽车板 Car plate:**主要用途: 汽车车顶、仪表板; 座椅靠板、车门板、窗框; 摩托车、沙滩车、代步车、高尔夫球车等外壳。

It is mainly used in to produce tops of cars and buses, instrument boards, backrest, car doors, window frames, shells of the motorcycles, golf vehicles, etc.



### 主要技术参数 Main Technical Parameters

型号 Model	JWS130/38-2200	JWS120/38-1400
适用原料 Material	PC, PMMA, GPPS, ABS	PC, PMMA, GPPS, ABS
制品宽度 Products Width	2200mm	1400mm
制品厚度 Products Thickness	1.5-10mm	1.5-10mm
挤出机规格 Extruder Specification	Ø130/38; Ø45/30	Ø120/38
最大挤出产量 Capacity (Max.)	550Kg/h	450Kg/h

备注: 以上规格参数如有变更, 恕不另行通知。Note: The specifications are subject to change without prior notice.

## PC/PMMA光学片材生产线 PC, PMMA Optic Sheet Extrusion Line

为了满足市场的需要, 金纬凭借先进的工艺技术及装备向用户提供了光学级片材生产线。根据原料的流变性设计的专用螺杆和精密的计量泵系统和模具保证了熔体的均匀稳定和片材优异的光学性能; 精密的压光系统给片材的机械物理性能提供了保障。

To meet the demands of market, JWELL supply customer PC PMMA optical sheet extrusion lines with advanced technology, the screws are specially designed according to the rheological property of raw material, precise melt pump system and T-die, which makes the extrusion melt is even and stable and the sheet has excellent optical performance. Precise calender system guarantees the mechanical & physical properties of sheets.

### PC、PMMA光学片材

产品主要应用于汽车工业; 电子、电器工业的薄膜开关; 电脑、手机、商务通的液晶显示屏; 太阳镜、太阳帽、镀膜、防护面罩; 特种印刷; 医药包装等领域。

### PC PMMA optic sheet

It is mainly used in automotive industry, film switch of electronics, LCD for computer, mobile, sunglass, helmet, special printing, medicine packing and so on areas.



### 主要技术参数 Main Technical Parameters

机型 Model	JW100-1300	JW120-1500	JW130-1600
制品宽度 Production width	1000mm	1200mm	1300mm
制品厚度 Production thickness	0.05-0.50mm磨砂片	0.125-1.2mm透明片	0.175-2.0mm透明片
挤出机规格 Extruder model	JWS100/38	JWS120/38	JWS130/35
设计挤出产量 Designed capacity	250kg/h	400kg/h	500kg/h

备注: 以上规格参数如有变更, 恕不另行通知。Note: The specifications are subject to change without prior notice.

## PC/PP/PE中空格子板生产线

PC, PP, PE Plastic Hollow Cross Section Plate Extrusion Line

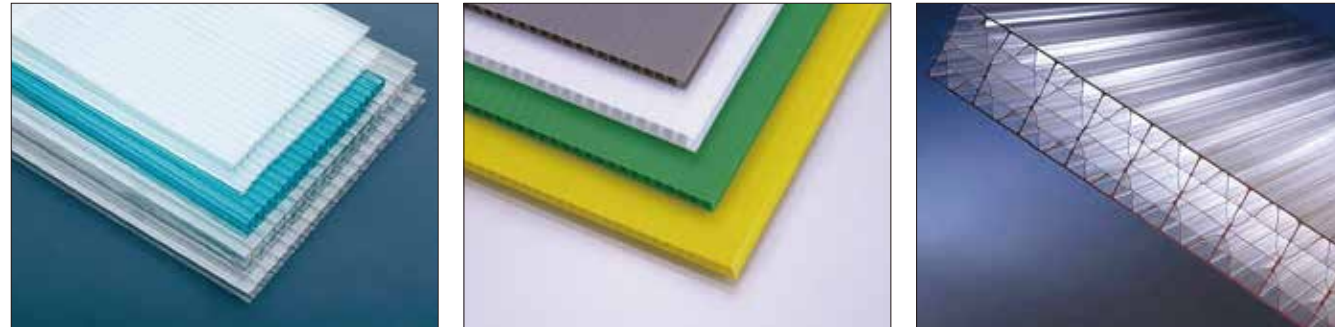

### PC阳光板应用:

- 办公楼、大厅、商场、体育场馆、公用设施的采光顶
- 车站、停车场、凉亭、休息厅走廊的雨棚
- 高速公路及城市高架路隔音屏障

### APPLICATION

- Construction of sunroof in buildings ,halls, shopping center ,stadium ,public places of entertainment and public facility.
- Ring shield of bus stations ,garages, pergolas, corridors.
- Transparent shields for security forces in nursery schools airports, factories.

### PP格子板应用:

- PP中空格子板因具有材质轻,强度高,防潮,良好的环保性能和二次加工性能,可加工成周转箱,包装箱等

### APPLICATION

- The pp hollow cross section plate is light and high strength ,moistureproof good environmental protection and refabrication performance.
- Can be processed into the reusable container,packing case, clapboard ,backing plate ,and culet.



### PC中空格子板机组主要技术参数 Main technical specification

挤出机规格 Model	Ø120, Ø45
制品宽度 Products width	2100mm
制品厚度 Products thickness	4-40mm
最大挤出产量 Capacity (Max.)	450kg/h

备注: 以上规格参数如有变更, 恕不另行通知。  
Note: The specifications are subject to change without prior notice.

### PP、PE中空格子板机组主要技术参数 Main technical specification

挤出机规格 Extruder specification	Ø120	Ø100
制品宽度 Products width	2100mm	1220mm
制品厚度 Products thickness	2-8mm	2-8mm
最大挤出产量 Capacity (Max.)	350kg/h	200kg/h

备注: 以上规格参数如有变更, 恕不另行通知。  
Note: The specifications are subject to change without prior notice.

## PP中空建筑模板一模双出生产线

PP Hollow Building Formwork Double Out Extrusion Line



PP 中空建筑模板一模双出生产线是常州金纬片板设备制造有限公司在传统 915mm 单出生产线的基础上, 经过不断创新, 不断验证后, 推出的全新产品, 在满足大产量, 低能耗的同时, 把产品质量的稳定性做到最佳。

PP hollow building formwork double out extrusion lines

Plate&Sheet Equipment Co.,Ltd produced PP one mold double out building template production line on the basis of the traditional 915mm single production line, that not only could meet the demand of large output and low energy.



### 特点:

1. 三层共挤生产线
2. 三层复合分配器
3. 多层格子模具
4. 三级定型板
5. 组合式牵引机
6. 自动定长切割机

### Characteristics:

1. Three layer coextrusion production line
2. Three layer composite distributor
3. Multi-layer lattice mold
4. Three grade type board
5. Combined tractor
6. Automatic fixed length cutting machine

### 主要技术参数 Main Technical Parameters

机型 Model	JWS130(80)-1320	JWS150(80)-2000	CJWH85(80/52)-2000
适用原料 Material	PP改性料modified material	PP改性料modified material	PP改性料modified material
制品宽度 Products width	915/1220mm	915mm*2	915mm*2
制品厚度 Products thickness	15-17mm	15-17mm	15-17mm
挤出机规格 Extruder specification	JWS130/35 JWS80/35	JWS150/35 JWS80/35	CJWH85 CJWH52 JWS80
最大挤出量 Capacity (Max.)	450 ~ 500KG/H	550 ~ 600KG/H	600 ~ 700KG/H

备注: 以上规格参数如有变更, 恕不另行通知。Note: The specifications are subject to change without prior notice.



## ABS/HIPS单层/多层板材生产线

### ABS, HIPS Single, Multi-layer Plate Extrusion Line



#### ABS、HIPS/GPPS冰箱板 Refrigerator board

主要用于冰箱冰柜门胆、内胆、抽屉、接水盘、饮水机等。

It has wide application in production of refrigerator door and inner gallbladder, drawers, water dispensers, etc.

#### ABS/PMMA复合洁具板 Sanitaryware plate

用于卫浴产品如：浴缸、淋浴房、蒸汽房、洗脸槽。

It is widely applied in the field of bath products, such as the bathtub, the shower cabinet, the vapor room, washing bowl, etc.

#### ABS/PC复合箱包板 Baggage plate

主要用于各种拉杆箱、行李箱、休闲包等箱包。

It is mainly applied in field of draw-bar boxes, luggage cases, recreation bags, etc.

#### ABS、ABS + PC合金料汽车板 Car plate

主要用途：汽车车顶、仪表板；座椅靠板、车门板、窗框；摩托车、沙滩车、代步车、高尔夫球车等外壳。

It is mainly used in to produce tops of cars and buses, instrument boards, backrest, car doors, window frames, shells of the motorcycles, golf vehicles, etc.



#### 主要技术参数 Main Technical Parameters

机型 Model	JW120/70/60-2200	JW120/60/45-1800	JW160/60-2200
适用原料 Material	ABS、PMMA	ABS、PS、HIPS	ABS、PS、HIPS
挤出机规格 Extruder specification	Ø120/38,70/35,60/35	Ø120/38,60/35,45/35	Ø160/38,60/35
共挤分层形式 Co-extrusion layer	A/B/C/B/A	A/B/C	A/B,A/B/A
制品宽度 Products width	2200mm	1800mm	2200mm
制品厚度 Products thickness	2-8mm	1-6mm	1-6mm
最大挤出量 Capacity (Max.)	600Kg/h	550Kg/h	1200Kg/h

备注：以上规格参数如有变更，恕不另行通知。Note:The specifications are subject to change without prior notice.

## PP/PE/ABS/PVC厚板生产线

### PP, PE, ABS, PVC Thick Plate Extrusion Line



#### PP厚板生产线 PP thick plate extrusion line

PP厚板，可广泛用于化学工业、食品行业、防腐行业、净化行业、环保设备生产行业。2000mm宽PP厚板生产线是金纬新开发的领先于同行的最稳定的生产线。

PP thick plate is an environmentally-friendly product and is widely applied in chemistry industry, food industry, anti-erosion industry, environmentally-friendly equipments industry, etc.PP thick plate extrusion line of 2000mm width is a newly developed line which is the most advanced and stable line compared with other competitors.

#### PE厚板生产线 PE thick plate extrusion line

聚乙烯 (PE) 板材广泛应用于化工、电力等工业上。HDPE板还可作为工程塑料应用在机械、化工等设备上，广泛用于制造冰球场墙板。

PE plate is widely applied in chemical and electric power industries. HDPE plate, known as engineering plastics, is used in mechanical and chemical equipments as well as ice hockey ring walls.

#### ABS厚板生产线 ABS thick plate extrusion line

ABS厚板广泛应用于家电、电子、包装、医疗器械等领域。

ABS thick plate is widely used in the home appliance, electronics, packaging, medical appliance.

#### PVC厚板生产线 PVC thick plate extrusion line

硬质PVC厚板广泛用于化工、石油、电镀、水净化处理设备、环保设备、矿山、医药电子、通讯、防腐蚀容器、设备电气的护罩，灯箱，广告装潢等行业。

Rigid PVC thick plate is widely used in chemical industry, petrol, electroplating, water purifying equipments, environment-friendly equipments, lamp house and advertisements, etc.



#### 主要技术参数 Main Technical Parameters

机型 Model	JW150-2000	JW170-2000	JWS180-2600	SJZ80/156-1500
适用原料 Suitable material	PP、PE、ABS	PP、PE、ABS	PP、PE、ABS	PVC
制品宽度 Products width	1220-1500mm	1200-1500mm	1500-2000mm	1220mm
制品厚度 Products thickness	3-30mm	3-30mm	3-30mm	3-30mm
挤出机规格 Extruder model	Ø150/35	Ø170/35	Ø180/35	JW80/156
设计挤出产量 Designed capacity	500Kg/h	700Kg/h	800kg/h	450 Kg/h

备注：以上规格参数如有变更，恕不另行通知。Note:The specifications are subject to change without prior notice.



## PEEK/PPS/PPSU冷推棒材板材生产线 PEEK, PPS, PPSU Cold Push Bar and Sheet Production Line



PEEK 中文名称为聚醚醚酮。主要运用在航天、医疗、制药和食品加工业得到了非常普遍的应用,如卫星上的气体分析仪结构件、热交换器刮片;因其优越的耐摩擦性能,在摩擦应用领域成为理想材料,如辊筒轴承、滑动轴承、阀门座、密封圈、泵耐磨环等。  
The Chinese name for PEEK is called polyether ether ketone. It has been widely used in aerospace, medical, pharmaceutical and food processing industries, such as gas analyzer structural parts and heat exchangers on satellites. Due to its excellent friction resistance, it has become an ideal material in the field of friction application, such as roller bearing, sliding bearing, valve seat, sealing ring, pump wear ring, etc.

PPS 塑料 (聚苯硫醚) 是一种综合性能优异的热塑性特种工程塑料。PPS 的主要用途还是在电子电器领域,如制作变压器骨架,高频线圈骨架、插头、插座、接线架、接触器转鼓鼓片及各种精密零件等。  
PPS plastic (polyphenylene sulfide) is a kind of thermoplastic special engineering plastic with excellent comprehensive performance. The main use of PPS is in the field of electronic appliances, such as making transformer skeletons, high-frequency coil bobbins, plugs, sockets, wiring frames, contactor drum drums and various precision parts.



### 主要技术参数 Main Technical Parameters

机型 Model	SJZ45/25
适用原料 Material	PEEK/PPS/POM
主机转速 Main engine rate of revolution	10-49r/min
主电机功率 Main motor power	11KW
最大挤出量 Capacity (Max.)	20KG/H

备注: 以上规格参数如有变更, 恕不另行通知。Note: The specifications are subject to change without prior notice.

## LFT/CFP/FRP/CFRT连续纤维增强复合材料生产线 LFT, CFP, FRP, CFRT Continuous Fiber Reinforced Composite Production Line



**连续纤维增强复合材料是由增强纤维材料:** 玻璃纤维(GF)、碳纤维(CF)、芳纶纤维(AF)、超高分子量聚乙烯纤维(UHMW-PE)、玄武岩纤维(BF)等, 通过特有工艺技术使得高强度的连续纤维与热塑性、热固性树脂相互间浸渍, 再经过挤压、牵伸等工艺形成的高强度、高韧性、可回收的新型热塑性复合材料; 常用的树脂基体有PET、ABS、PP、PC、PA、PPS、POM等环保型热塑性材料。

**Continuous fiber reinforced composite material is made of reinforced fiber material:** glass fiber(GF), carbon fiber (CF), aramid fiber(AF), ultra high molecular polyethylene fiber(UHMW-PE), basalt fiber(BF) by using special process technology to makes high strength continuous fiber and thermal plastic&thermosetting resin soak with each other. Then extrusion and drawing process are used to form the high strength, high toughness and recyclable thermalplastic resin composite material .commonly used plastic are PET, ABS, PP, PC, PA, PPS, POM and other environmentally friendly thermoplastic materials.

**产品应用:** 军工、航天、船舶、汽车轻量化、电子、风电、建筑、医疗、体育休闲等领域。

**Product application:** Military, spaceflight, ships, automotive light weight, electronics, wind and electricity, construction, medical, sports and leisure and other fields.



### 主要技术参数 Main Technical Parameters

机型 Model	制品宽度 Products width(mm)	制品厚度 Products thickness(mm)	最大速度 Max.speed(m/min)
JWS-1800	1200-1600	0.1-0.8	12
JWS-3000	2000-2500	0.1-0.8	12

备注: 以上规格参数如有变更, 恕不另行通知。Note: The specifications are subject to change without prior notice.



## 超宽幅土工膜/防水卷材生产线

Extra-width Geomembrane/Waterproof Sheet Extrusion Line



工业与民用建筑的屋面防水, 包括种植屋面、平屋面、坡屋面、建筑物地下防水: 包括水库、堤坝、水池防水、隧道、粮库、人防工程、垃圾掩埋场、人工湖防水等。制品厚度 0.5-3mm, 宽度 1000-8500mm。

For waterproofing usage in industrial & civil buildings including the green roof, flat roof and the sloping roof. Underground waterproof: reservoir, dam, dpool, waterproof usage in tunnel, grain depot, artificial engineering, landfill, artificial lake. Product thickness 0.5-3mm, width 1000-8500mm.



### 主要技术参数 Main Technical Parameters

原料 Material	PE	PE
厚度 Width	0.5-3mm	0.5-3mm
宽度范围 Product width range	1000-4000mm	4000-8500mm

备注: 以上规格参数如有变更, 恕不另行通知。Note: The specifications are subject to change without prior notice.

## 复合型高分子防水卷材生产线

High Polymer Composite Waterproof Sheet Extrusion Line

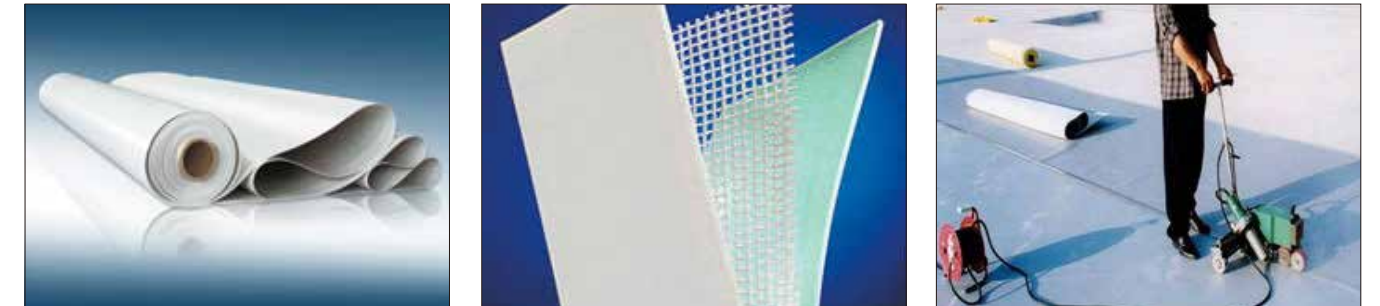

适合多种物料的生产, 包括 PVC、TPO、PE 等防水卷材; 适合多种产品结构形式厚度 0.5-3mm, 宽度 1000-2000mm 的防水卷材, 包括:

均质卷材 (代号 H): 不采用内增强材料或背衬材料的防水卷材;  
带纤维背衬卷材 (代号 L): 用织物如聚酯无纺布等复合在卷材下表面的防水卷材;

内增强卷材 (代号 P): 用聚酯网格布在卷材中间增强的防水卷材;  
内增强卷材 (代号 G): 用玻纤网格布在卷材中间增强的防水卷材。

Used for different kinds of plastic material, such as PVC, TPO, PE etc. Being able to produce below sheets with thickness 0.5-3mm, width 1000-2000mm:

Plastic roll sheet (model: H): without coating with inner reinforced material or outer material;  
Roll sheet with outer fiber (Model: L): coating with fiber or non-woven fabric;

Inner reinforced roll sheet (Model: P): Inner layer coats with polyester mesh;  
Inner reinforced roll sheet (Model: G): Inner layer coats with glass fiber.



### 主要技术参数 Main Technical Parameters

机型 Model	SJZ92/188-SJZ80/156	SJP130/36-SJZ92/188	JWS150-JWS120
制品宽度 Products width	1200-2000mm	2000mm	2000mm
制品厚度 Products thickness	0.5-3.0mm	0.5-3.0mm	1-2mm
设计挤出产量 Capacity	800-900kg/h	1200-1300kg/h	1000-1100kg/h

备注: 以上规格参数如有变更, 恕不另行通知。Note: The specifications are subject to change without prior notice.



## 蓄排水板生产线 Water Drainage Sheet Extrusion Line



排水的构成：排水板由高密度聚乙烯（HDPE）制成的，具有圆锥形凸台的一种立体空间支撑结构的，即具有排水功能，又具有蓄水功能的一种轻型板材，板材空间刚度极高，抗压性强。

排水板的优点：传统的排水方式使用砖石瓦块作为导滤层，使用较多的鹅卵石或碎石作为滤水层，将水排到指定地点。而用排水板取代鹅卵石滤水层来排水则省时、省力又节能、节省投资、以及降低建筑物的荷载。

排水板的应用：主要用于地下工程顶板或屋顶绿化中。与常规工艺相比，将排水板和土工布复合，具有排水、防水、透气、保湿、隔根等多种功能集于一体。制品厚度0.5-3mm，宽度2000-5000mm。

Water Drainage Sheet: It is made of HDPE material, outer figure is of cone salient, functions of draining water and storing water, features of high stiffness and pressure resistance.

Advantages: Traditional drainage water prefers brick tile and cobblestone for draining water. Water drainage sheet is used for replacing the traditional method to save time, energy, investment and reduce load of building.

Application: Used for underground construction or roofing green. Coating with geomembrane material, features of draining. Product thickness 0.5-3mm and width 2000-5000mm.



### 主要技术参数 Main Technical Parameters

机型 Model	JWS-120	JWS-150
制品宽度 Products width	2000-3000mm	2000-5000mm
制品厚度 Products thickness	0.5-3.0mm	0.5-3.0mm
设计挤出产量 Capacity	600kg/h	1000kg/h

备注：以上规格参数如有变更，恕不另行通知。Note:The specifications are subject to change without prior notice.

## HDPE、PP止水板生产线 HDPE/PP T-Grip Sheet Extrusion Line

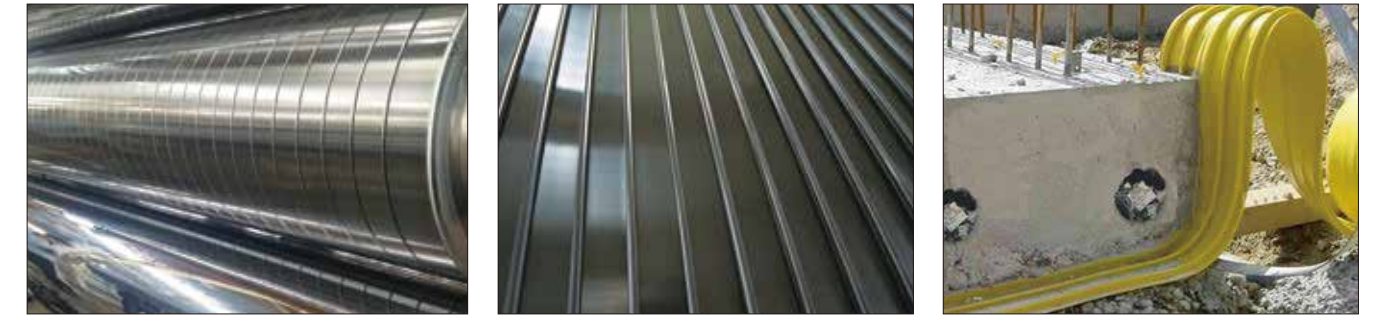

塑料止水板是由高密度聚乙烯（HDPE）、聚丙烯（PP）树脂挤出成型工艺制成的止水材料。

塑料止水板主要用于混凝土浇注时设置在施工缝及变形缝内与混凝土构成为一体的基础工程，如隧道、涵洞、引水渡槽、拦水坝、贮液构筑物、地下设施等；它利用高分子材料具有的弹性变形特性在建筑构造接缝中起到防漏、防渗作用，且具有耐腐蚀、耐久性好等特点。制品宽度1000mm-3000mm，产量300-500kg/h。

Plastic T-Grip sheet is made of HDPE and PP, produced by extrusion process.

T-grip sheet is mainly used in basis construction concrete casting of the construction joints and deformation constitute the basis of engineering for the integration and joints of concrete, such as tunnel, culvert, aqueduct, dam, reservoir structures, underground facilities; Because of elastic deformation characteristics, people use it for seal up and impermeable of construction, features anti-erosion, good durability wear durableness. Product width 1000-3000mm, machine output 300-500kg/h.



### 主要技术参数 Main Technical Parameters

机型 Model	JWS120-I	JWS150-I
产品宽度 Width of sheet	1000-1500mm	2000-3000mm
最大挤出产量 Maxim extrusion output	350kg/h	500kg/h

备注：以上规格参数如有变更，恕不另行通知。Note:The specifications are subject to change without prior notice.



## PVC硬质片材/PVC装饰片材/PVC仿大理石板挤出生产线 PVC Rigid Sheet/PVC Decoration Sheet/PVC Imitation Marble Board Extrusion Line



PVC硬质片材分为两种：透明硬质片材和不透明硬质片材两种：

PVC透明硬片：药品/礼品/文具包装，LED扩散板；

PVC木塑板材：装饰板，门板，广泛应用于建筑装饰行业；

PVC仿大理石板材：

a、板材表面覆仿大理石纹装饰膜，或者热转印仿大理石纹并UV固化处理，良好的抗划伤性，耐刮擦性；

b、板材花色、品种多样，施工方便；

c、在室内墙体装潢中替代大理石等天然石材，良好的耐老化、抗紫外线、耐黄变，绿色环保、无辐射。

PVC rigid sheets are divided into two types: transparent sheet and non-transparent sheet:

PVC Transparent Rigid Sheet: Medicine/Gift/Stationery packaging, LED diffuser plate;

PVC Wood-Plastic plate: Decorative panels, door panels, widely used in the building decoration industry;

PVC Imitation Marble Board:

a. The surface of the board is covered with imitation marble pattern, or heat transfer imitation marble pattern and UV curing treatment, good scratch resistance.

b. Board with variety of color, it's convenient to construct.

c. Replace the natural stone such as marble in the interior wall decoration, good ageing resistance, UV resistance, yellowing resistance, green environmental protection, no radiation.

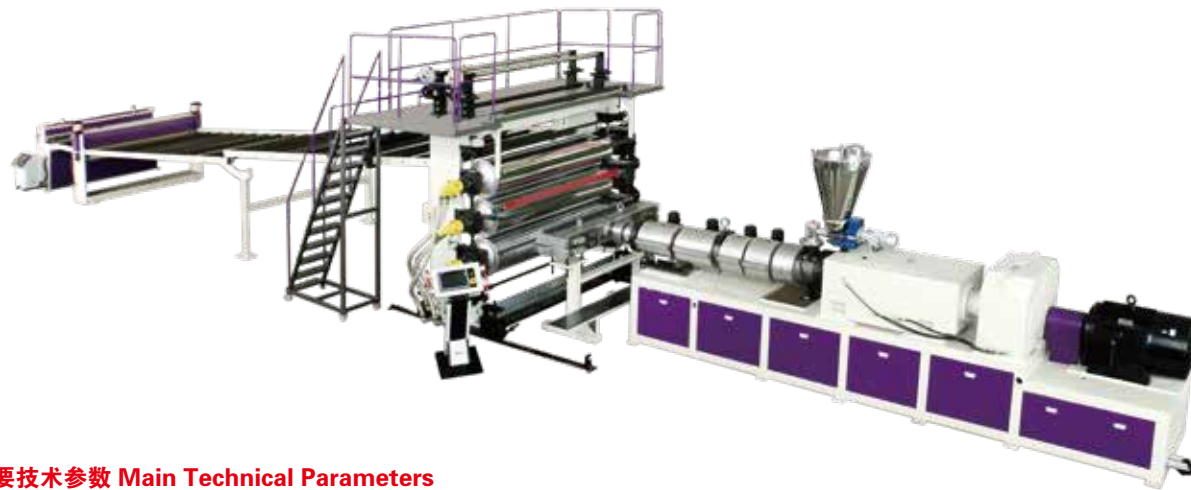

### 主要技术参数 Main Technical Parameters

种类 Species	透明片材 Transparent Sheet	木塑板材 Wood-Plastic Board	UV仿大理石 Imitation Marble Board	PVC装饰板 PVC Decoration sheet
型号 Model	SJZ80/156	JSJZ80/156	SJZ80/156	SJZ92/188
适用原料 Material	PVC	PVC	PVC	PVC
制品宽度 Products Width(mm)	1220	1220	1220	2000
制品厚度 Products Thickness(mm)	0.5-3	1.5-3	4-5	1.5-6
产量 Output (kg/h)	400	450	600	600-700

备注：以上规格参数如有变更，恕不另行通知。Note: The specifications are subject to change without prior notice.

## PVC厚板挤出生产线 PVC Thick Plate Extrusion Line

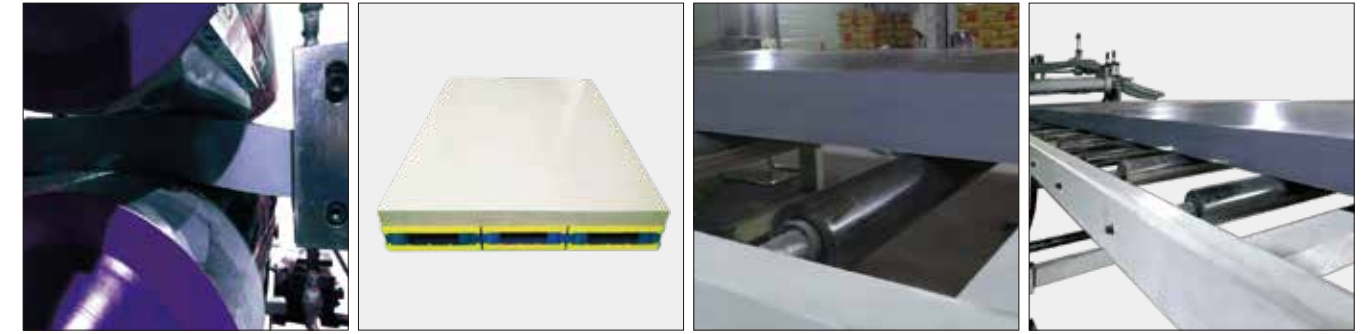

**PVC厚板特点及用途：** PVC厚板表面光洁，平整，不吸水，不变形，易于加工等优点，是优秀的热成型材料，能替代部分不锈钢和其它耐腐蚀合成材料，被广泛用于化工、石油、电镀、水净化处理设备、环保设备等行业。

**PVC thick plate features and uses:** PVC thick plate surface is smooth, flat, non-absorbent, non-deformable, easy to process, etc. It is an excellent thermoforming material that can replace some stainless steel and other corrosion-resistant synthetic materials and is widely used in chemical industry. Oil, electroplating, water purification equipment, environmental protection equipment and other industries.



### 主要技术参数 Main Technical Parameters

型号 Model	SJZ80/156
适用原料 Material	PVC
制品宽度 Products Width(mm)	1220
制品厚度 Products Thickness(mm)	5-100
产量 Output (Kg/h)	450

备注：以上规格参数如有变更，恕不另行通知。Note: The specifications are subject to change without prior notice.



## LVT复合地板生产线 LVT Composite Floor Production Line

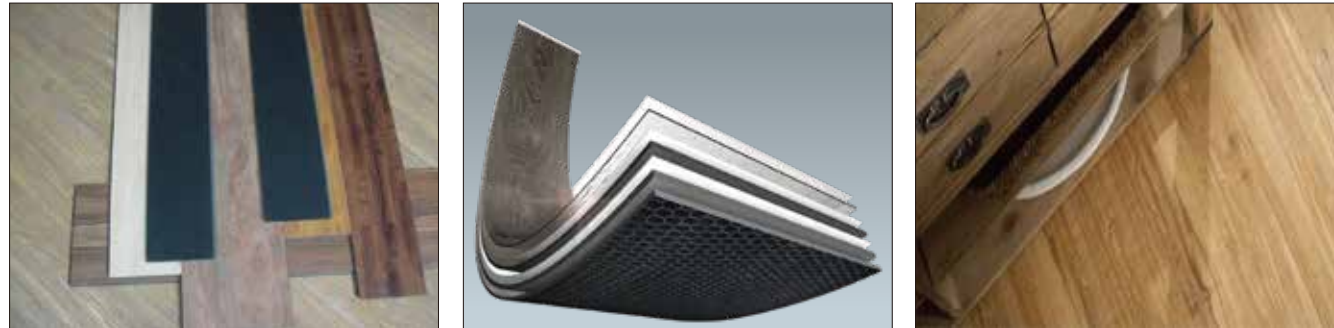

LVT软质复合地板生产线由挤出机挤出地板基材，再经过一套六辊复合机对基材与印刷层，耐磨层，防滑层进行同时复合，通过对放卷张力，耐磨层预热的精确控制，达到放卷时不起皱，不收缩，不变形等效果，挤出复合生产效率高，产品质量稳定。

LVT soft composite floor production line, production line by extruder extrusion floor base material, then through a set of six roller for base material and printing layer composite machine, wear-resisting layer, layer of compound at the same time, through the rolling tension, wear-resisting layer accurate control of preheating, to put the volume not wrinkle, does not shrink, deformation, extrusion compound high production efficiency, product quality is stable.



### 主要技术参数 Main Technical Parameters

机型 Model	SJZ80/156
适用原料 Material	PVC
制品宽度 Products width	1200mm
制品厚度 Products thickness	1.5-4mm
挤出机规格 Extruder specification	SJZ80/156
辊筒规格 Roller specification	Ø400
辊筒数量 No of rolls	6PS
最大挤出量 Capacity (Max.)	500KG/H
主电机功率 Main motor power	75KW

备注：以上规格参数如有变更，恕不另行通知。Note:The specifications are subject to change without prior notice.

## SPC复合地板生产线 SPC Composite Floor Production Line



SPC复合地板生产线是由挤出机挤出PVC的基材，用四辊压延机组，分别把PVC彩膜+PVC耐磨层+PVC底膜，一次性压贴复合而成的产品，工艺简单、贴合靠热量完成，不含胶水。

SPC复合地板生产线优势

- 1、防水、防潮。根本解决了木质产品对潮湿和多水环境中吸水受潮后容易腐烂、膨胀变形的问题，可以使用到传统木制品不能应用的环境中。
- 2、多姿多彩，可供选择的颜色众多。既具有天然木质感和木质纹理，又可以根据自己的个性来定制需要的颜色。
- 3、高环保性、无污染、无公害、可循环利用。产品不含苯及甲醛，为环保产品，可循环利用大大节约了木材使用量，适合可持续发展的国策，造福社会。
- 4、高防火性。能有效阻燃，防火等级达到B1级，遇火自熄，不产生任何有毒气体。
- 5、安装简单，施工便捷，不需要繁杂的施工工艺，节省安装时间和费用。
- 6、不龟裂，不膨胀，不变形，无需维修与养护，便于清洁，节省后期维修和保养费用。

SPC composite floor extrude by PVC'S base material get through four roll calender machines , and PVC color film + PVC wearing layer + PVC basis of membrane , next press and paste these films to be products ,simple process , complete the paste that depend on heat ,there is no glue.

SPC composite floor production line advantage

- 1.Waterproof and moistureproof, it can fundamentally solve the wooden product problems like easily be rotted and dilated deformation after absorbing water or affected with wet environment . Therefore, our company's WPC floor can be used in this kind of environment which the traditional wood product cannot.
- 2.Colorful , many colors are optional.There are natural wooden feeling and wooden texture, and also you can choose the color you need according to your personality.
- 3.Environmental protection , non- pollution, pollution-free, recycle . The products do not contain benzene and formaldehyde ,it's a environmental products, recyclability reduce usage of wood,and that is suitable for the sustainable development of national policy and it also benefits society.



### 主要技术参数 Main Technical Parameters

机型 Model	80/156	92/188	110/220
制品宽度 Product width	1050	1220	1220
制品厚度 Product thickness	3-8	3-8	3-8
最大挤出量 Capacity	400-500KG/H	800-1000KG/H	1200-1400KG/H
主电机功率 Main motor power	75KW	110KW	160KW

备注：以上规格参数如有变更，恕不另行通知。Note:The specifications are subject to change without prior notice.



## PE加碳黑铜塑复合生产线 PE Carbon Black Copper-plastic Composite Production Line



复合型导电高分子是在本身不具备导电性的高分子材料中掺混入大量导电物质，如炭黑、金属粉、箔等，通过分散，表面铜皮复合等方法构成的复合材料。

Composite conductive polymer is a composite material made by mixing a large number of conductive materials, such as carbon black, metal powder, foil, etc., into the polymer material which is not conductive itself, and the surface laminated with copper sheet.

与传统导电材料相比较,复合型导电高分子材料具有许多独特的性能。

Compared with traditional conductive materials, composite conductive polymer has many unique properties.



## PS\PC电子载带挤出机 PS\PC Electronic Narrow Band Extruder



PS\PC电子载带属于包装类产品，主要用于IC、电阻、电感、电容、连接器、保险丝、开关等电子元器件的包装。这种产品目前都是PS与PC进行三层复合挤出成型。

PS\PC narrow band is a kind of packaging products, mainly for the IC, resistance, inductance, capacitance, connectors, fuses, switches and other electronic components of the packaging. This product is currently PS and PC for three layers of composite extrusion.



### 主要技术参数 Main Technical Parameters

挤出机型号 Model	螺杆直径 mm	长径比 L/D	电机功率 KW	螺杆转速 rpm	挤出量 kg/h	设备中心高 mm
JWS45	45	28:1	11	10-75	10-15	1000
JWS35	35	28:1	7.5	10-75	8-12	1000

备注：以上规格参数如有变更，恕不另行通知。Note: The specifications are subject to change without prior notice.



## TPO/PVC+PP发泡汽车内饰表皮复合压花生产线 TPO/PVC+PP Production Line



汽车内饰表皮复合材料应用于中高级汽车仪表板表皮和汽车侧门板, 座椅等内饰, 该生产线可在线实现复合压花一次成型, 具有生产效率高, 复合粘结牢固, 花纹更改便利等优点;

Automobile interior skin composite materials are used in the interior of mid-to-high-end automobile instrument panel skins, automobile side door panels, seats and other interiors. This production line can realize online composite embossing and one-time shaping. It has advantages of high production efficiency, firm composite bonding, and convenient pattern modification.



### 主要技术参数 Main Technical Parameters

机型 Model	FH-1600/1800mm
复合厚度 Products thickness	0.5-0.8mm
制品宽度 Products width	1600-1800mm
最大速度 Max speed	10m/min
主机功率 Main motor power	280KW

备注: 以上规格参数如有变更, 恕不另行通知。Note: The specifications are subject to change without prior notice.

## PLA 3D打印材料 PLA 3D printing material



PLA即聚乳酸, 是人们最常用的3D打印材料。PLA由自然产品例如玉米淀粉制成的生物降解和生物活性热塑性聚酯电容器, 使它相比其他塑料更环保。PLA可用于不需要承受高压的零件、原型和产品。

PLA, is the most commonly used 3D-printed material PLA is a biodegradable and bioactive thermoplastic polyester capacitor made from natural products such as corn starch, making it more environmentally friendly than other plastics and can be used in parts prototypes and products that do not need to withstand high pressures.

PLA的相容性、可降解性、机械性能和物理性能良好, 适用于吹塑、热塑等各种加工方法, 加工方便, 应用十分广泛。

PLA has good compatibility, degradability, mechanical and physical properties, and is suitable for various processing methods such as blow molding and thermoplastic, etc. PLA is easy to process and widely used.



### 主要技术参数 Main Technical Parameters

机型 Model	共挤线 Multi layer
挤出机规格 Specification of extruder	JWS45
制品规格 Specification	1.75mm/2.85mm
主电机功率 Main motor power	7.5KW
最大挤出产量 Capacity (Max)	20KG/H

备注: 以上规格参数如有变更, 恕不另行通知。Note: The specifications are subject to change without prior notice.



## 单层或多层共挤流延膜生产线 Single Layer Or Multi-Layer Cast Film Extrusion Line

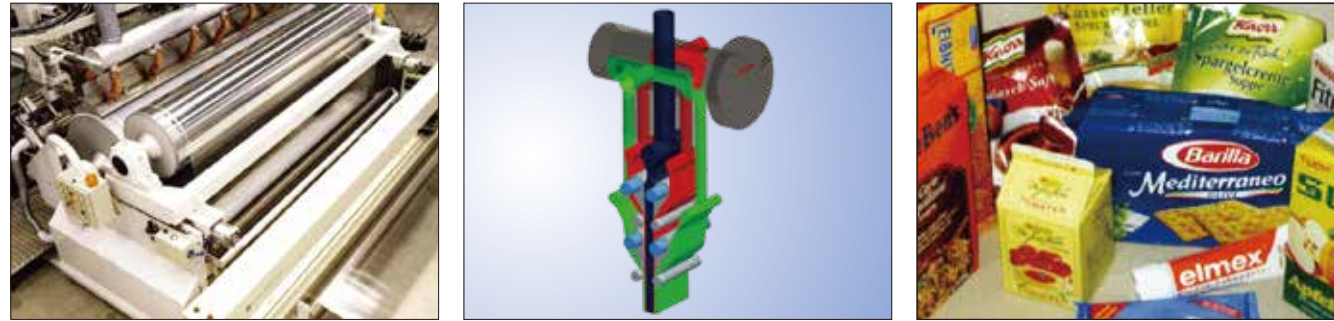

### 单层或多层共挤流延膜生产线 Single layer or multi-layer cast film extrusion line

主要用于生产CPP CPE EVA PVB 单层、多层光膜；CPP CPE EVA PVB 单层、多层压花膜；CPP CPE 透气膜。

Mainly used for producing CPP CPE EVA single, multi-layer flat film; CPP CPE EVA single, multi-layer embossed film; CPP CPE air free film.

### PVB/SGP夹胶膜生产线 PVB/SGP flim extrusion line

主要用于生产安全夹胶玻璃用PVB中间膜。

It is for producing PVB and EVA film which used in the middle layer of laminated glass.

### PVDF背膜生产线 PVDF flim extrusion line

主要用于生产水处理用PVDF膜、户外建筑用PVDF膜、锂电池用PVDF膜和太阳能电池背膜等特殊功能性薄膜。

This extrusion line is mainly used for producing the PVDF film for treatment of production water, outdoor buildings, lithium battery, and the back membrane of solar cell, other special film.

### 主要技术参数 Main Technical Parameters

机组型号 Model	JW90/33, JW45/30	JW120/33, JW65/33	JW150/33, JW90/33
树脂 Material	PP-Homo均聚聚丙烯, PP-Copo共聚聚丙烯		
薄膜宽度 Film width	18-250 μ m		
薄膜厚度 Film thickness	3层或5层 3 or 5 layers		
共挤结构 Coextrusion structures	1800mm	3000mm	4500mm
辊筒直径 Roller dia.	600mm	800mm	1000mm
设计线速度 Designed production speed	150m/min	180m/min	250m/min

备注：以上规格参数如有变更，恕不另行通知。Note: The specifications are subject to change without prior notice.

## 小型实验机挤出设备 Small Laboratorial Extrusion Equipment

### 小型试验机挤出设备 Small testing extrusion line

金纬公司提供的小型试验机挤出设备，可完成挤出、流延、制片、拉伸、复合等挤出成型的加工实验。主要应用于各大化工院校、塑料研究所等科研机构的高分子材料的性能加工测试和高分子产品企业的研发部门的新产品开发以及普通塑料制品企业的定制产品打样工作等。

The small testing extrusion lines provided by Changzhou JWELL can meet the demands of extrusion, casting, sheet production, stretching and composite etc. processing test. These lines are used by some Chemical Colleges and Plastics Research Institutes to process and test the performance of the polymer material; It is also for developing new products or making samples and other application in plastic factory's research department.

复合型导电高分子是在本身不具备导电性的高分子材料中掺混入大量导电物质，如炭黑、金属粉、箔等，通过分散，表面铜皮复合等方法构成的复合材料。

Composite conductive polymer is a composite material made by mixing a large number of conductive materials, such as carbon black, metal powder, foil, etc., into the polymer material which is not conductive itself, and the surface laminated with copper sheet.

与传统导电材料相比较，复合型导电高分子材料具有许多独特的性能。

Compared with traditional conductive materials, composite conductive polymer has many unique properties.





## 其他特殊的塑料片板生产线 Other Plastic Sheet And Plate Extrusion Line

### TPU 片材生产线 TPU sheet extrusion line

TPU 具有卓越的高张力、高拉力、强韧和耐老化的特性,属于成熟的环保材料。TPU 已被广泛应用于: 鞋材、成衣、充气玩具、水上及水下之运动器材、医疗器材、健身器材、汽车椅座材料、雨伞、皮箱、皮包等。  
TPU has excellent high tension, high strength, toughness and anti-aging, belongs to the mature environmental protection material.TPU has been widely use: shoe, cloth, inflatable toys, water and underwater sports equipment, medical equipment, fitness equipment, car seat material, umbrella, suitcase, leather bag, etc.



### PE 蓄电池隔板生产线 PE battery separating plate extrusion Line

隔板蓄电池的重要组成, PE隔板是蓄电池隔板的换代产品, 随着我国汽车行业发展及普及, PE隔板市场将进一步扩大。

It is an important part of battery. PE separating plate is a new style of battery separator. With the development of car industry in China, the market share of PE separating plate will be greatly increased.



### 塑料土工格栅生产线 Plastic geogrid extrusion Line

产品广泛应用于水利、公路、铁路、煤矿、建筑等工程领域。如用于建坝、护坝、护坡, 防汛防洪网笼, 高速公路、铁路、路基加固, 挡土墙护网、矿井顶网, 由于在工程应用中表现出的优越性能, 以及产品低成本、高效率的特点, 市场前景广阔。

It is widely used in irrigation, highway, railway, mine and building project, for example it's used to build dam, protect dam and slope, protect network of preventing flood, fix the roadbed and etc. The product has a high perspective among the markets because of its effective features.



### 钢材钢卷防锈用 PP、PE 塑料包装板材生产线

#### PP, PE plastic packing plate for rust prevention of iron and steel extrusion Line

钢卷包装用塑料端护板。塑料保护板、端护板、内外护角圈、端护圈、包装盒、垫片等。金纬也可以提供钢材包装专用三层共挤PE/PP发泡板材生产线。

protection board for steel roll packing. Plastic protection board, terminal protection board, inside and outside angle protection ring, terminal protection ring, packing case, gasket and so on. Jwell can provide three-layer co-extrusion PE/PP foaming board production line only for steel packing.



### PP 发泡片材生产线 PP foam sheet extrusion line

聚丙烯PP发泡片材是采用物理发泡工艺, 发泡倍率达到1-8倍,它具有轻质、隔热、隔音、缓冲防震, 是一种绿色环保材料, 可广泛应用于制作文具、食品包装、电子材料、装饰材料以及汽车装饰板等行业。

Polypropylene (PP) foam sheet use the physical foam process, foam ratio reach 1-8 times, it has light weight, heat insulation, sound insulation, cushion, is a kind of green environmental protection material, which can be widely applied in the stationery, food packaging, electronic materials, decoration materials and automobile decorative,etc.

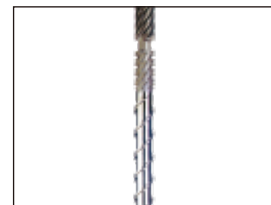

### 纵向拉伸生产线( MDO ) Lognitudinal stretching equipment extrusion line

纵向拉伸生产线(简称 MDO)主要应用于 PP、PE 锂离子电池隔膜; PP、PE 卫材透气膜; PP、PE、PET 热收缩包装行业等单向拉伸薄膜领域。

Lognitudinal stretch equipment (short name is MDO) is mainly used for PP、PE lithium electric film; PP、PE breathable film; PP、PE、PET thermo-shrinkage packing industrial, etc single stretching film industrial.



### PP 蜂窝板生产线 PP Honeycomb Board Extrusion Line

应用于乘用车的行李箱盖板、行李箱隔板、行李箱地毯基板、侧围装饰板、顶棚等内饰部位。

Used for car trunk cover board, trunk clapboard, trunk carpet substrate, side wall decoration board, ceiling etc. interior place.



### PVC 结皮发泡、木塑发泡板材生产线

#### PVC skinning foaming、WPC foaming board extrusion line

PVC发泡板及木塑发泡板的应用于轮船、飞机、客车、火车车厢、顶蓬、厢体芯层、内部装潢用板和建筑物外墙板、内装饰用板、住宅、办公室、公共场所建筑物隔间、商用装饰架、无尘室用板、吊顶板、家庭厨柜、吊柜和家居。通过油漆印刷、贴膜和热压设备, 可以生产各类仿木制品。

Transportation industrial: Ship, plane, bus, chamber of train,roofing, core layer,inner decoration board.Construction and decoration industrial: outer wall board, inner decoration board, housing, office, public construction board, furniture. cupboard, roofing. Adopting printing, film coating and thermo-embossing equipment, will get all kinds of emulational wooden product.



### XPE、IXPE 交联聚乙烯发泡卷材生产线 XPE,IXPE Foaming Coil Extrusion Line

用于: 中央空调工程、管道工程、大型容器、高档复合屋面系统; 箱包内衬、集成电路板等电器的导静电包装; 汽车缓冲绝热、装饰材料等领域。

This product can be widely used in central air conditioning project, pipe project, large container, advanced composite layer; bag lining, packaging of integrated circuit board,cushion and heat insulation for car, decoration material and so on.



### PC 中空格子板、U 型锁扣板生产线 PC hollow sheet, U-shaped /U locked sheet extrusion line

办公楼、大厅、商场、体育场馆、公用设施的采光顶, 车站、停车场、凉亭、休息厅走廊的雨棚, 高速公路及城市高架路隔音屏障。

Construction of sunroof in buildings ,halls, shopping center ,stadium ,public places of entertainment and public facility.Rain shield of bus stations, garages, pergolas, corridors.Transparent shields for security forces in nursery schools airports, factories.









**企业风采：品质管理 技术研发 国际交流 客户服务 员工培训**

**Quality Control Technology Research International Communication Customer Service Staff Training**



-   
 24小时服务  
 24 Hours Service
-   
 86-519  
 87878918  
 客户服务热线  
 Customer Service Hotline
-   
 培训  
 Training
-   
 交钥匙工程  
 Turn-Key Project